

SUNRIDGE

86- SERIES

.100" (2.54MM) CENTERLINE DUAL ROW VERTICAL PIN HEADER, HIGH HOUSING PROFILE

-Sizes in 1 to 40 pins/per row

-Straddle mount option available (as-04 suffix)

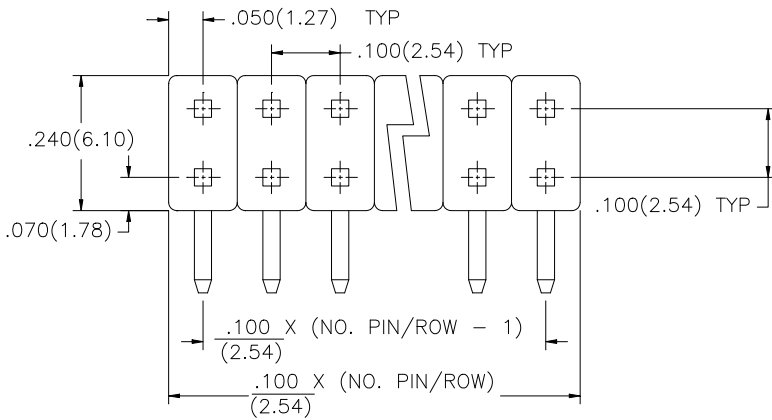

CONTACT END SOLDER TAIL

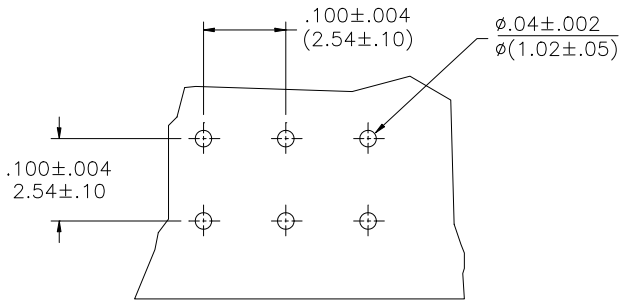
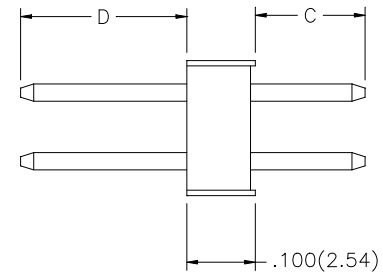

P/N DESIGNATION

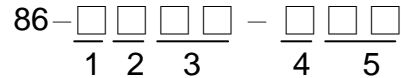

- | | |
|-----------------------------|--|
| 1: HOUSING MATL- | 4: PLATING OPTION |
| 0: PBT | T: ENTIRE CONTACT TIN PLATED |
| 1: PCT | 0: GOLD FLASH ON CONTACT END |
| 2: NUMBER OF ROWS- | 2: 10 u" GOLD ON CONTACT END |
| S: SINGLE ROWS | 3: 15 u" GOLD ON CONTACT END |
| D: DUAL ROWS | 6: 30 u" GOLD ON CONTACT END |
| T: TRIPLE ROWS | |
| 3: NUMBER OF TOTAL CONTACTS | 5: PIN CONFIGURATION |
| | SOLDER TAIL "C" DIM CONTACT END "D" DIM |
| | 01 .105" (2.68mm) .237" (6.00mm) |
| | 02 .105" (2.68mm) .318" (8.08mm) |
| | 03 SAME AS "01" EXCEPT SOLDER TAIL CRIMPED |
| | 04 STRADDLE MOUNT SEE ILLUSTRATION |

VARIETY OF CUSTOM OPTION AVAILABLE UPON REQUEST

RECOMMENDED PCB LAYOUT

A FOR -03 SUFFIX

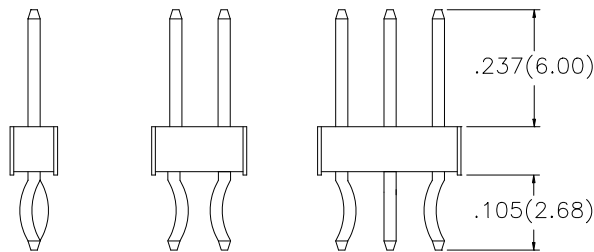

CRIMPED SOLDER TAIL AT SELECTIVE POSITIONS FOR BOARD RETENTION

FOR -04 SUFFIX, STRADDLE EDGE MOUNT

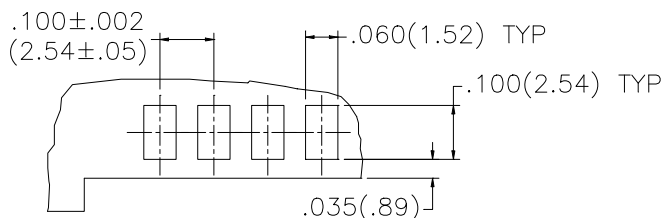
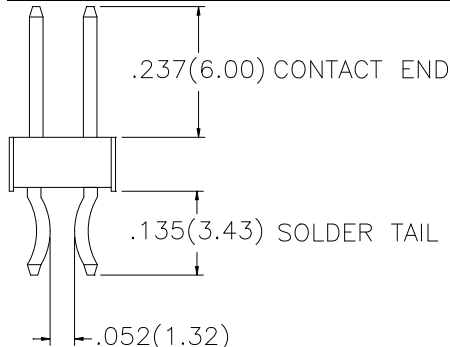

RECOMMENDED PCB LAYOUT FOR STRADDLE DEGE MOUNT