

# SUNRIDGE

## 85- SERIES

### .100" (2.54MM) CENTERLINE PIN HEADER, VERTICAL, STANDARD HOUSING PROFILE

- Sizes in 1 to 40 pins/per row, in single, dual and triple rows

- Straddle mount option available (-04 suffix for dual row version)

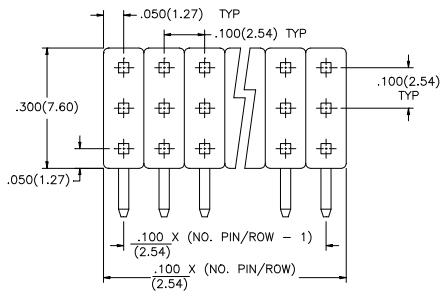
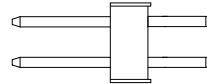
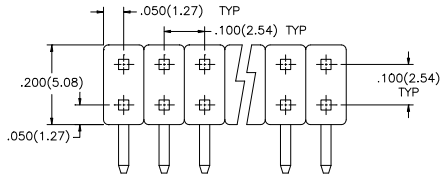
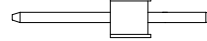
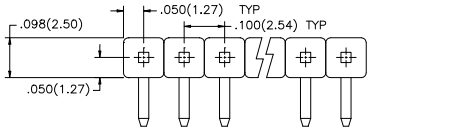

(CONTACT TAIL) (SOLDER TAIL)

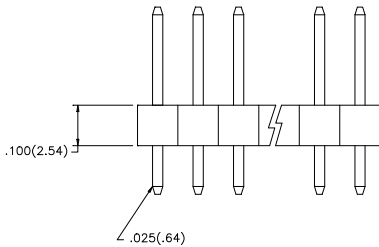
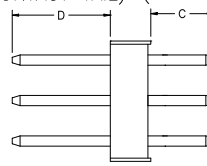

SQUARE PIN TYP

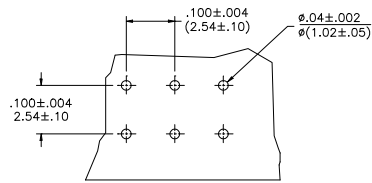

RECOMMENDED PCB LAYOUT

### P/N DESIGNATION

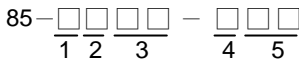

- |                             |  |
|-----------------------------|--|
| 1: HOUSING MATL-            | 4: PLATING OPTION                          |
| 0: PBT                      | T: ENTIRE CONTACT TIN PLATED               |
| 1: PCT                      | 0: GOLD FLASH ON CONTACT END               |
| 2: NUMBER OF ROWS-          | 2: 10 u" GOLD ON CONTACT END               |
| S: SINGLE ROWS              | 3: 15 u" GOLD ON CONTACT END               |
| D: DUAL ROWS                | 6: 30 u" GOLD ON CONTACT END               |
| T: TRIPLE ROWS              |  |
| 3: NUMBER OF TOTAL CONTACTS | 5: PIN CONFIGURATION                       |
|                             | CONTACT END "D" DIM                        |
|                             | 01 .105"(2.68mm) .237"(6.00mm)             |
|                             | 02 .105"(2.68mm) .318"(8.08mm)             |
|                             | 03 SAME AS "01" EXCEPT SOLDER TAIL CRIMPED |
|                             | 04 STRADDLE MOUNT SEE ILLUSTRATION         |

VARIETY OF CUSTOM OPTION AVAILABLE UPON REQUEST

### FOR -04 SUFFIX, STRADDLE EDGE MOUNT

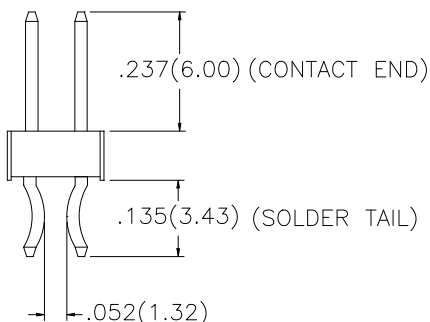

A FOR - 03 SUFFIX

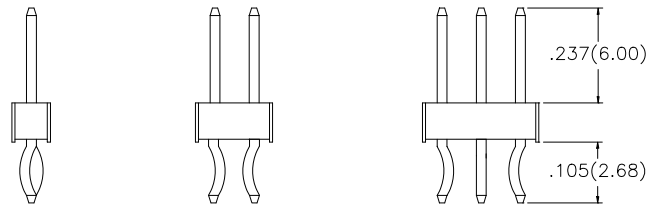

CRIMPED SOLDER TAIL AT SELECTIVE POSITIONS FOR BOARD RETENTION

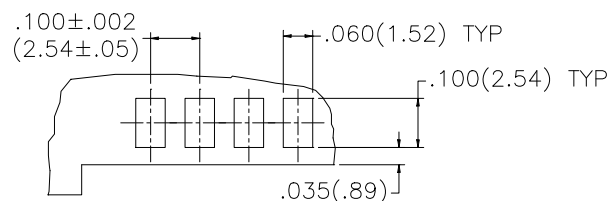

RECOMMENDED PCB LAYOUT FOR STRADDLE EDGE MOUNT